

PD140FNT60QMU-02C



Through Beam



Description

The PD140 sensor consists of an emitter, which sends out invisible, infrared light, and a receiver, capable of detecting the light from the emitter.

The sensor is encapsulated in a robust, vandal-proof aluminium/polycarbonate housing.

The lenses are adjustable in both $\pm 100^\circ$ horizontal and $\pm 15^\circ$ vertical directions, which allows flexible mounting, even when emitter and receiver are mounted at different heights.

The aspherical lens design gives a superior homogeneous light beam over the total beam angle.

- Sensor test function: the emitter has a built-in test input designed to mute the emitter and thus evaluate the sensor function. The test function is to be controlled and monitored by the door controller.

Main features

- Designed for Industrial doors and gates
- ESPE type 2, Performance level d
- For door or gate widths up to 60 m
- Modulated, infrared light
- Supply voltage: 12 to 24 VAC/DC
- 1 A, SPDT relay output
- Analogue voltage output or flashing LED indication for optical alignment help
- Built-in holder for green laser alignment accessory tool
- Yellow LED for output indication
- Green LED indication for power ON
- Connection: self-lifting terminal block, 1,5 mm² (AWG 16)
- Emitter test input
- Robust vandal-proof aluminium/polycarbonate housing
- IP65, NEMA 1. 2. 3. 3R. 3RX. 3SX. 3X. 5. 12. 12K rating
- CE, EN12453, EN12978, UL325 and UL508 approved

Main functions

- Designed for domestic and industrial doors and gates
- Detects presence or absence of persons or vehicles by interruption of the light beam from the emitter to receiver



References

Product selection key

PD140FNT60 -02C

Enter the code entering the corresponding option instead of

| Code | Option | Description | - |
|--------------------------|------------|---|---|
| P | - | Photoelectric sensor | |
| D | - | Rectangular housing | |
| 140 | - | Length of housing | |
| F | - | Aluminium | |
| N | - | Not used | |
| T | - | Through-beam | |
| 60 | - | Distance [m] | |
| <input type="checkbox"/> | QMU | Matched sensor set (Receiver and Emitter) | |
| | Q | SPDT relay (Receiver) | Sensor is only available as a matched set |
| | MU | Mute input (Emitter) | Sensor is only available as a matched set |
| -02C | - | Black | |

Type selection

| Function | - | Code |
|----------------------|---------------|--------------------------|
| Receiver and Emitter | Sensor set | PD140FNT60QMU-02C |
| Receiver | Not available | PD140FNT60Q-02C |
| Emitter | Not available | PD140FNT60MU-02C |

Structure

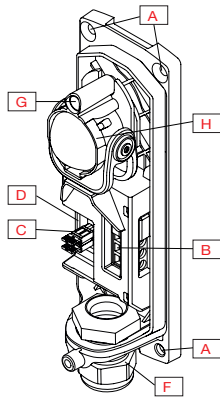

Fig. 1 Emitter

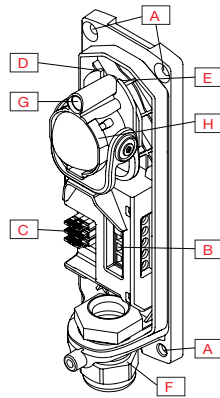

Fig. 2 Receiver

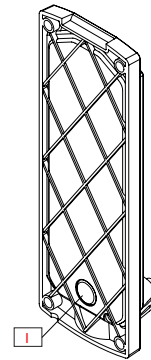

Fig. 3 Rear view

| Element | Component | Element | Component |
|---------|----------------------------------|---------|--------------------------------|
| A | Fixing holes for sensor mounting | F | Cable gland for cable entry |
| B | Terminal block | G | Hole for laser adjustment tool |
| C | Jumpers | H | Lens adjustment |
| D | Green LED | I | Alternative cable entry |
| E | Yellow LED | | |

Sensing

Detection

| | | |
|---|--------------------|---|
| Rated operating distance (S_n) | ≤ 60 m | @ target, PD140 emitter and excess gain 4 |
| Sensitivity adjustment (Receiver) | 12 m ... 60 m | Jumper pos 1 |
| | 6 m ... 12 m | Jumper pos 2 |
| | 0.6 m ... 6 m | Jumper pos 3 |
| Blind zone | 0.6 m | |
| Hysteresis | 10 ... 20% | |
| Light source | 850 nm | Infrared |
| Light type | Infrared modulated | |
| Detection angle | ≤ ± 5° | |
| Emitter beam angle | ≤ ± 5° | |
| Light spot size | 3.7 m | @30 m (half sensing distance) |
| Lens adjustment | ± 100° | Horizontal |
| | ± 15° | Vertical |

Accuracy

| | |
|--------------------------|-----------|
| Temperature drift | ≤ 0.3%/°C |
| Repeatability | < 5% |



Detection diagram

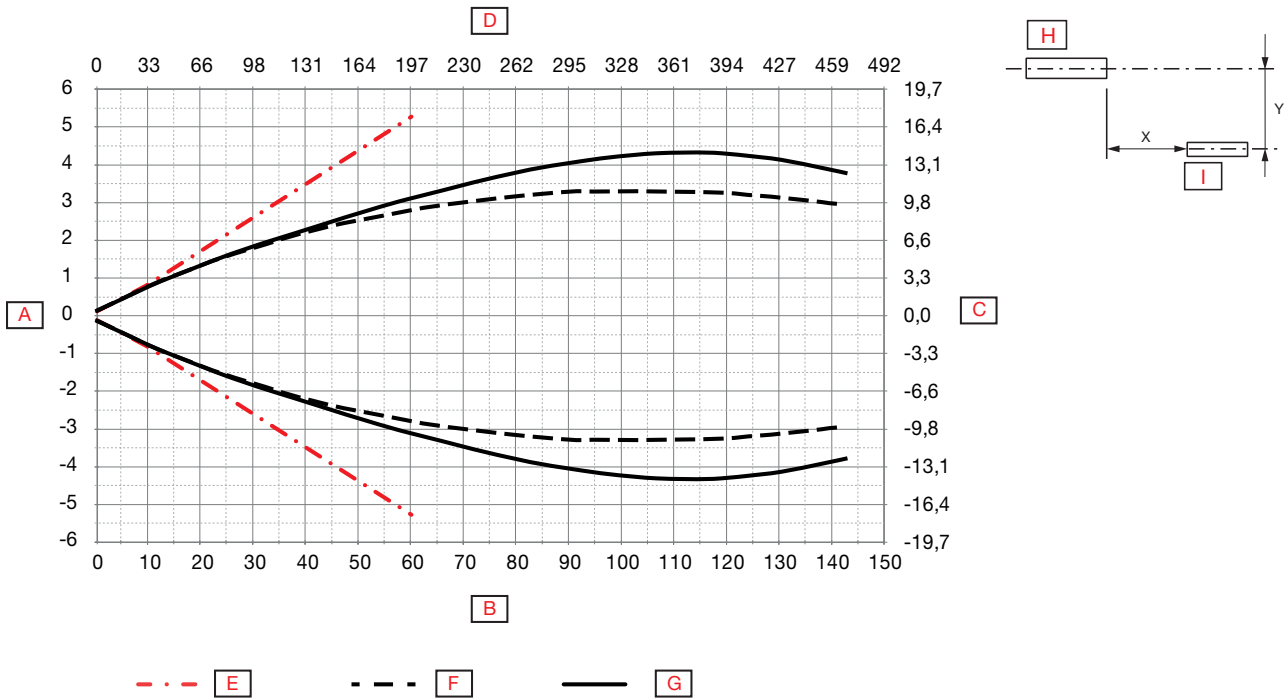

| | | | |
|----------|------------------------|----------|----------|
| A | Detection width [m] | F | OFF |
| B | Sensing range [m] | G | ON |
| C | Detection width [feet] | H | Emitter |
| D | Sensing range [feet] | I | Receiver |
| E | Limits | | |



Excess gain

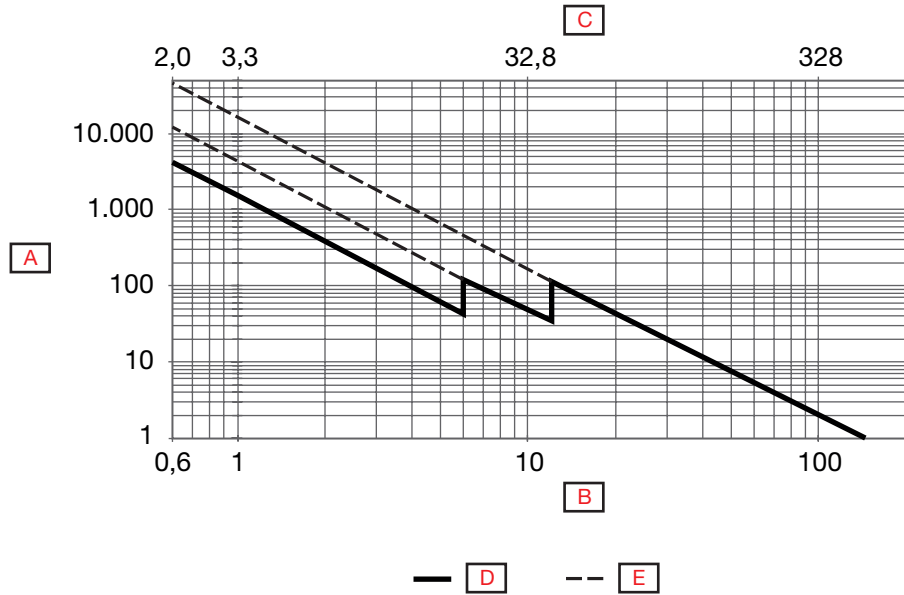

| | | | |
|----------|----------------------|----------|---|
| A | Excess gain | D | ESPE 2, legal detection angle ⁵⁾ |
| B | Sensing range [m] | E | ESPE 2, illegal detection angle ⁵⁾ |
| C | Sensing range [feet] | | |

⁵⁾ See detection diagram

Features

Power Supply

| | | |
|---|-------------------------------------|----------|
| Rated operational voltage ($U_{e-min} - U_{e-max}$) | 12 ... 24 V AC/DC (ripple included) | |
| Rated operational voltage (U_B) | 10.2 ... 35 V DC | |
| | 10.2 ... 26.4 V AC | |
| Ripple (U_{rpp}) | Within limits of U_B min | |
| No load supply current (I_o) DC | ≤ 55 mA @ U_B max | Emitter |
| | ≤ 50 mA @ U_B max | Receiver |
| No load supply current (I_o) AC | ≤ 100 mA @ U_B max | Emitter |
| | ≤ 100 mA @ U_B max | Receiver |
| Power-ON delay (t_v) | ≤ 200 ms | Emitter |
| | ≤ 200 ms | Receiver |

Outputs

| | | |
|---|--|--|
| Output functions | SPDT relay | |
| Output switching function | N.O. and N.C. | |
| Output current | < 1 A / 30 VDC | Continuous(I_o) |
| | < 0.5 A / 50 VAC | Continuous(I_o) |
| Minimum operational current (I_m) | ≥ 1 mA @ 5 V | |
| Mechanical lifetime | $\geq 5\,000\,000$ cycles | |
| Electrical lifetime (typical) | $> 100\,000$ cycles @ Resistive load AC-1 and DC-1 | |
| Protection | reverse polarity and transients | Emitter and Receiver |
| Utilization category | AC-1 | Non-inductive or slightly inductive loads, resistive load |
| | DC-1 | EN 60947-4-1 |
| | AC-14 | Control of small electromagnetic loads EN 60947-5-1 |
| | DC-13 | Control of electromagnets EN 60947-5-1 (with freewheeling diode) |



Operation diagram

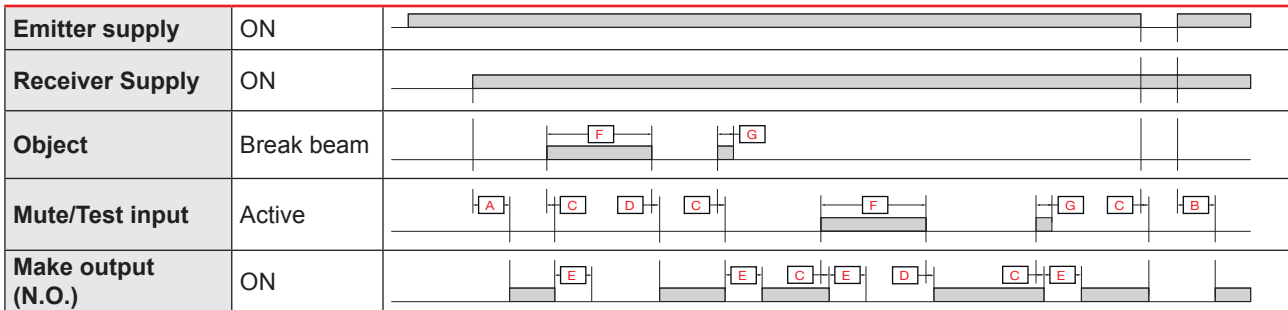

| | | | |
|----------|--------------------------------|----------|--|
| A | Receiver startup time (150 ms) | E | OFF Hold Time (80 ms) |
| B | Emitter startup time (150 ms) | F | Beam obstruction / mute active > 80 ms |
| C | Break response time (8 ms) | G | Beam obstruction / mute active < 80 ms |
| D | Make response time (8 ms) | | |

Response times

| | | |
|--------------------------------|---------------------------|---------|
| Operating frequency (f) | 10 impulses / sec. | |
| Response times | t _{ON} (ON-OFF) | < 8 ms |
| | t _{OFF} (OFF-ON) | < 8 ms |
| | OFF Hold time | > 80 ms |

Indication

Receiver

| Green LED | Yellow LED | Power | Output |
|-----------|---------------------|------------|----------------------|
| ON | OFF | ON | OFF |
| ON | ON | ON | ON |
| ON | Flash ¹⁾ | ON; EG ≥ 4 | OFF / Alignment mode |
| OFF | Flash ¹⁾ | EG < 4 | OFF / Alignment mode |

¹⁾ Slow flashing or OFF = Not aligned, Higher flash rate= Better optical alignment
EG = Excess gain

Emitter

| Green LED | Power | Emitting |
|-----------|-------|------------|
| ON | ON | Yes |
| OFF | ON | No (muted) |



Environmental

| | | |
|---|---|--|
| Ambient temperature | -25°... +60°C (-13°... +140°F) | Operating ^{2) 3)} |
| | -40° ... +70°C (-40° ... +158°F) | Storage ²⁾ |
| Ambient light | ≥ 100 000 lux | Incandescent light @ 3000 ... 3200 °K (EN 60947-5-2) |
| | ≥ 10 000 lux ⁴⁾ | Incandescent light 3200 °K (EN 61496-2) |
| | ≥ 3 000 lux ⁴⁾ | Fluorescent light (EN 61496-2) |
| | 0.05 J @ 200 Hz to 0.5 J @ 5 Hz ⁴⁾ | Stroboscopic light (EN 61496-2) |
| | 3 to 5 J @ 0.5 to 2 Hz ⁴⁾ | Flashing beacon light (EN 61496-2) |
| Vibration | 10 ...150 Hz, 1.0 mm/15 g | EN 60068-2-6 |
| Shock | 30 g _n / 11ms, 6 pos, 6 neg per axis | EN60068-2-27 |
| Drop test | 2 x 1 m and 100 x 0.5 m | EN 60068-2-31 |
| Rated insulation voltage (U_i) | 50 VDC | |
| Dielectric insulation voltage | ≥ 4000 VAC rms | 50/60 Hz for 1 min. |
| Rated impulse withstand voltage | ≥ 2 kV | 1.2/50 μs |
| Pollution degree | 3 | EN60947-1 |
| Overvoltage category | III | IEC60664; EN60947-1 |
| Degree of protection | IP65 | IEC60539; EN60947-1 |
| NEMA Enclosure Types | Indoor + outdoor: 3, 3R, 3RX, 3SX, 3X | NEMA 250 |
| | Indoor: 1, 2, 5, 12, 12K | NEMA 250 |
| Ambient humidity range | < 50% @ 70°C ²⁾ | |
| | RH < 90% @ 20°C ²⁾ | |

²⁾ With no icing or condensation

³⁾ UL325 -25°... +55°C

⁴⁾ Failure to danger (worst case alignment)

EMC

| | | |
|--|--|---------------|
| Electrostatic discharge immunity test | ± 8 kV @ air discharge | IEC 61000-4-2 |
| | ± 15 kV @ contact discharge (Closed sensor with aluminium housing) | |
| | ± 8 kV @ contact discharge (during installation) | |
| Radiated radio-frequency electromagnetic field immunity test (80 MHz ... 1 GHz and 1.4 GHz ... 2 GHz) | 10 V/m | IEC 61000-4-3 |
| Electrical fast transient/Burst immunity test | 4 kV / 5 kHz using the capacitive coupling clamp | IEC 61000-4-4 |
| Conducted disturbances induced by radio-frequency fields immunity test (150 kHz ... 80 MHz) | 10 V rms | IEC 61000-4-6 |
| Power frequency magnetic field immunity test | 300 A/m | IEC 61000-4-8 |

Mechanics/electronics

▶ Connection

| | | |
|-----------------------|--|----------|
| Cable diameter | Ø 5 ... 10 mm | |
| Connection | 3-pole screw terminal | Emitter |
| | 5-pole screw terminal | Receiver |
| Terminal | Self-lifting terminal block, 1.5 mm ² (AWG 16) □ 2.6 x 2 mm | |

▶ Wiring

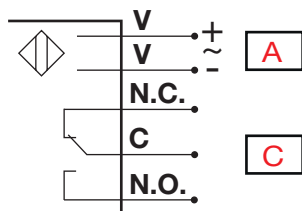

Fig. 4 Receiver

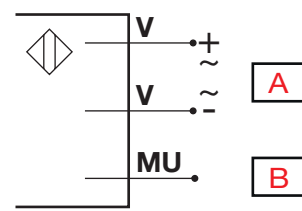

Fig. 5 Emitter

| | | | |
|----------|-------------------------|----------|----------------|
| A | Power supply | C | Relay contacts |
| B | Mute input (Test input) | | |

▶ Housing

| | |
|--------------------|-----------------------|
| Cover | Aluminium, Black |
| Window | PC, Black |
| Back part | PBT, Black |
| Sealing | Neoprene |
| Cable gland | PA6, Light grey |
| Dimensions | 140 x 51 x 46 mm |
| Weight | ≤ 460 g (matched set) |

Dimensions (mm)

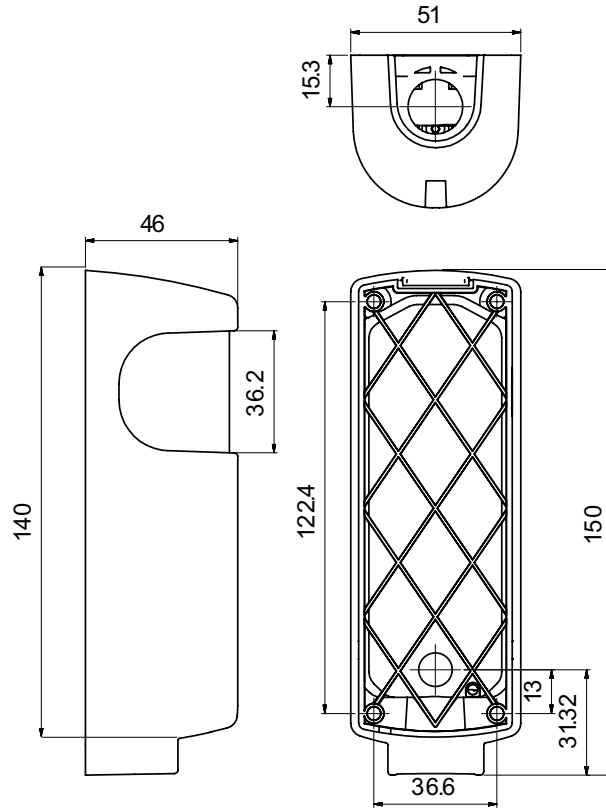



Compatibility and conformity

▶ Approvals and markings

| | | |
|---|--|--|
| General reference | Sensor designed according to EN60947-5-2 | |
| MTTF_d related to product life time | 49.9 years @ 40°C (+104°F) | EN ISO 13849-1 (Parts count method, annex D.1), SN 29500 |
| MTTF_d related to safety device, performance level_d | 1332 years @ 40°C (+104°F) | EN ISO 13849-1, SN 29500 |
| CE-marking | | |
| Approvals | | |
| ESPE category | 2 | EN61496-2 |
| Performance level (PL) | d | EN12453 |
| PFH_d | 8.57 x 10 ⁻⁸ Errors per hour | EN ISO 13849-1 |
| Mission Time | 20 years | EN ISO 13849-1 |

Delivery contents and accessories

Delivery contents

- Photoelectric sensor set: PD140FNT60Q-02C + PD140FNT60MU-02C
- Accessory bag (Screws, plugs, blind caps, cable glands)
- Packaging: Card board box

Accessories

- Laser alignment tool: APD140-LA01
- Laser alignment tool without batteries (Battery: DL1/3N, CR1/3N 3V - Lithium): APD140-LA02
- Alignment test cable: APD140-TC01

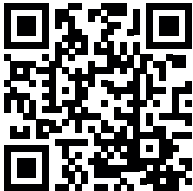

COPYRIGHT ©2016
Content subject to change. Download the PDF: www.productselection.net